



Trimble Connect

3D Modellen in Trimble Connect



CONSTRUSOFT



Bouwen
Wonen
Interieur

vmbo

7 juni 2023

Agenda

- Check-in
- Introductie Trimble Connect
- Trimble Connect inzetten in het onderwijs
Direct zelf ervaren!
- Overige mogelijkheden
- Samenvatting & Vragen

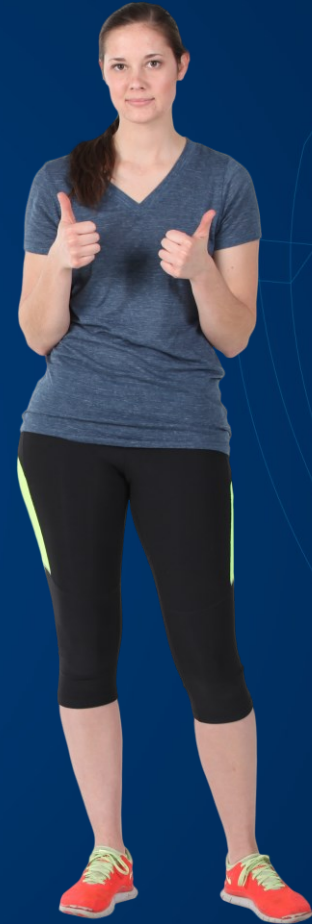

The image features abstract geometric shapes in the top-left and bottom-left corners. These shapes are composed of thin, light blue lines forming various polygons and curved lines, creating a modern, architectural feel. The top-left corner shows several overlapping shapes, while the bottom-left corner features a more complex arrangement of shapes, including what looks like a stylized 'C' or a similar curved form.

Check-in

Check-in

- Christophe Schunck – Accountmanager Construsoft
5 jaar in dienst
HAN Commerciële Economie + post hbo Sales
Focus op onderwijs en aannemers



Check-in

- VDC Consultant
 - 5 jaar
 - HAN Bouwkunde | Constructie
 - Constructeur – Constructief Modelleur – BIM

-  **Trimble** Connect

-  **Tekla** Structures

-  **SketchUp** Pro



Frans van Bekkum

Construsoft

- Leverancier en adviseur BIM-software
- 175 medewerkers, 15 kantoren, 33 landen
- Hoofdkantoor Zevenaar
- Actief sinds 1995

- Nederlandstalige ondersteuning

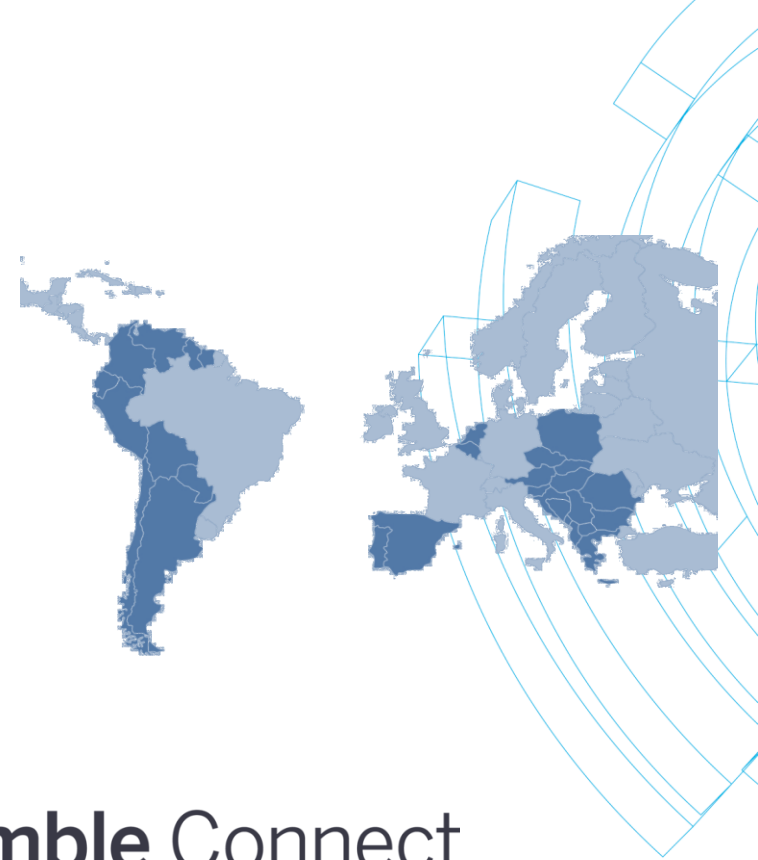

Trimble Snapshot



Transport en Logistiek

Landbouw

Gebouwen



NASDAQ:
TRMB



\$3.13 mld.
Omzet



14%
R&D investering

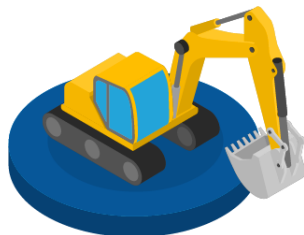

Infrastructuur

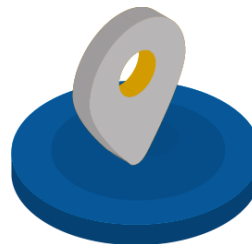

Geospatial

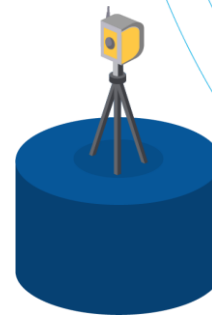

GPS

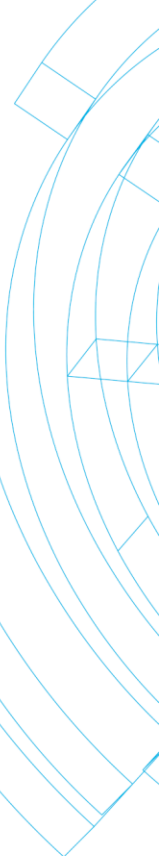

Wie zijn onze klanten?

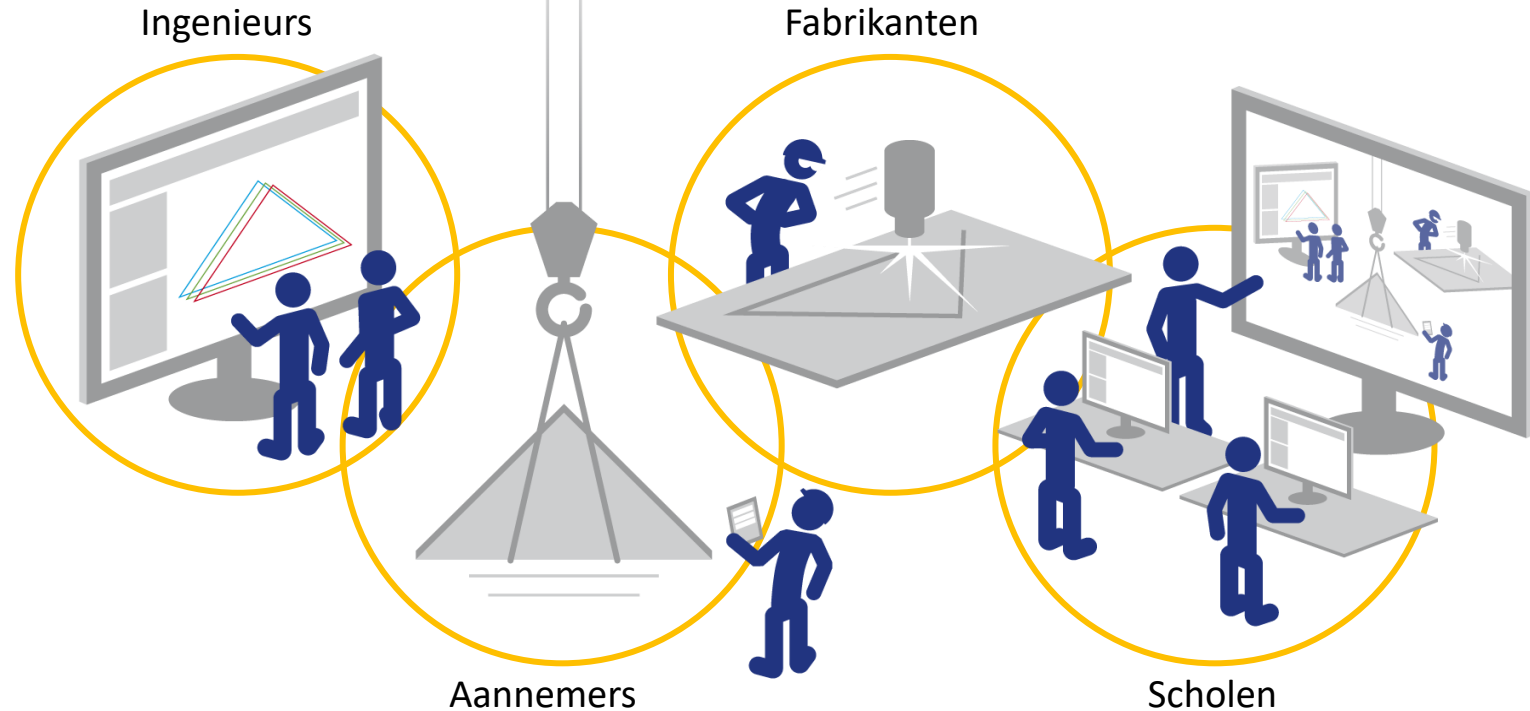

Stadiums



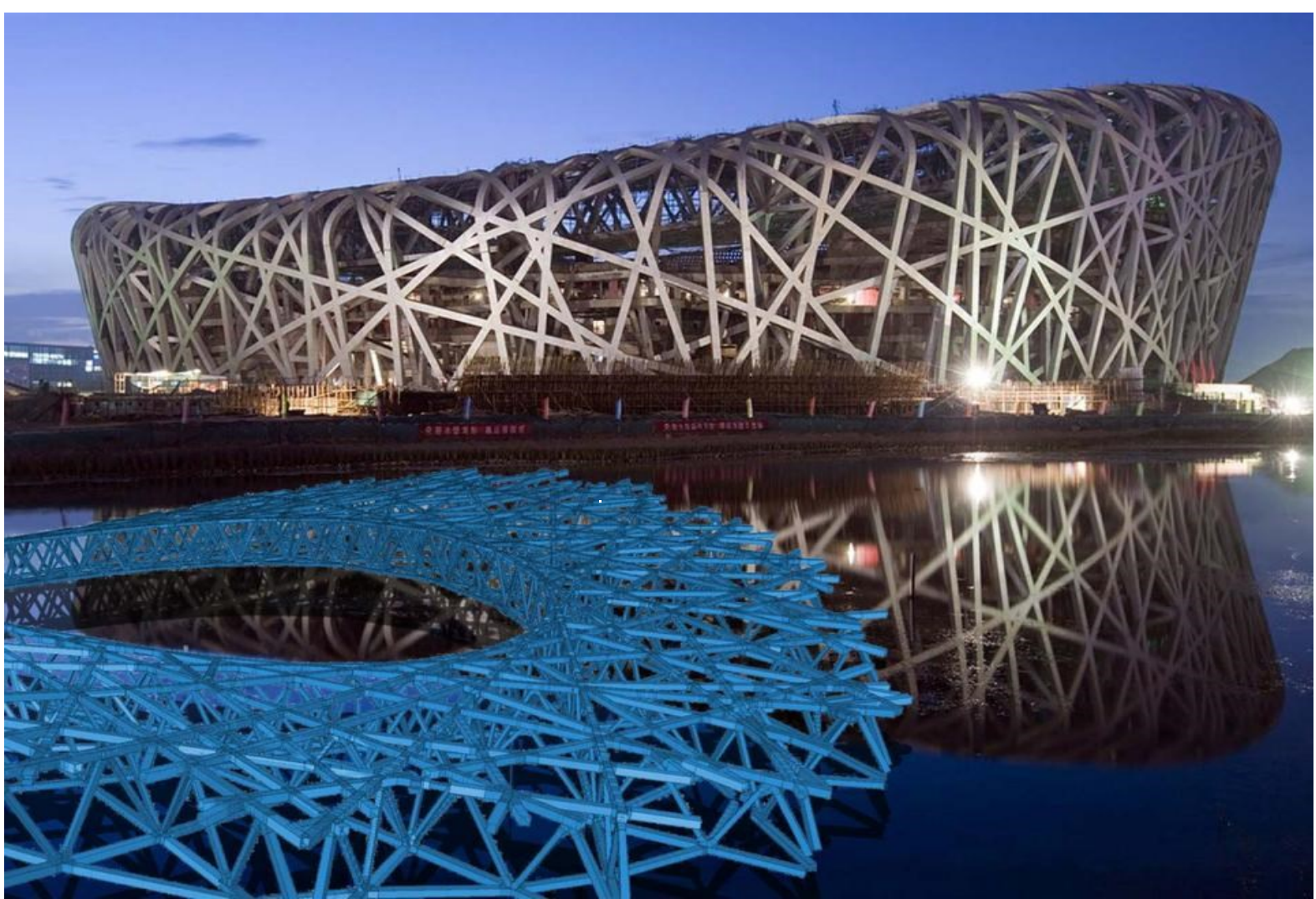

CONSTRUSOFT

Andere sportaccomodaties

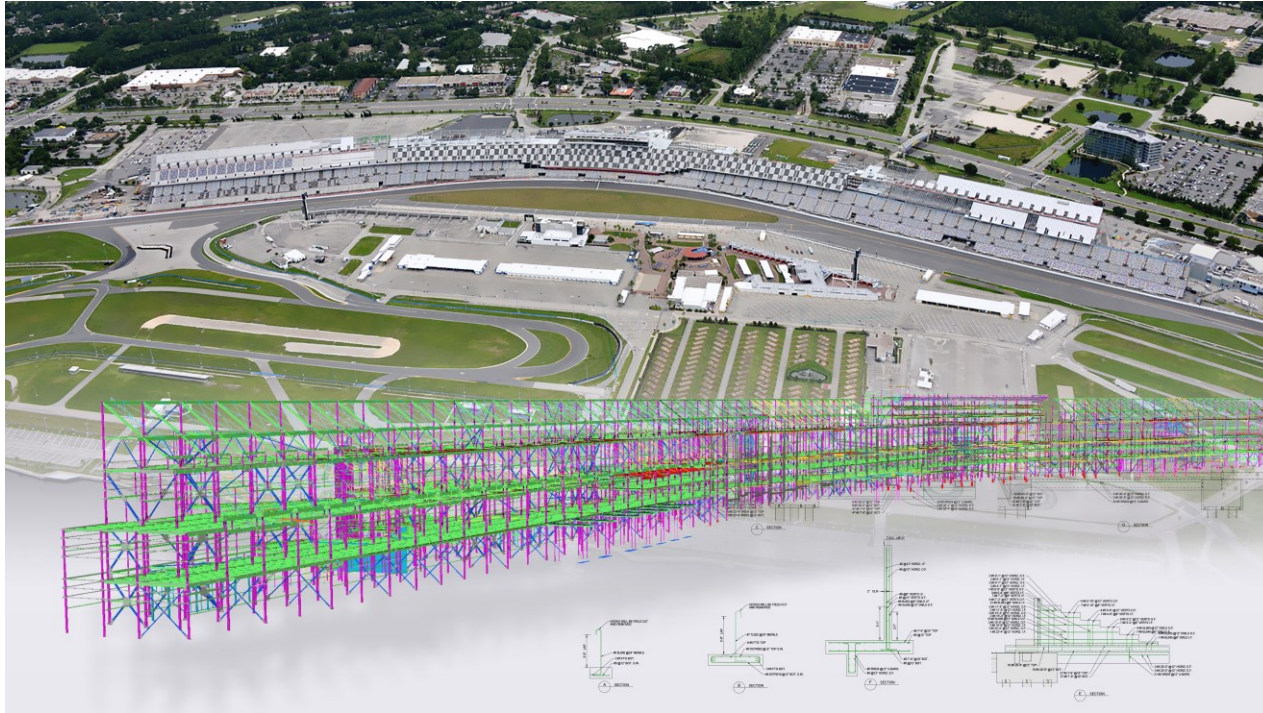



CONSTRUSOFT







CONSTRUSOFT

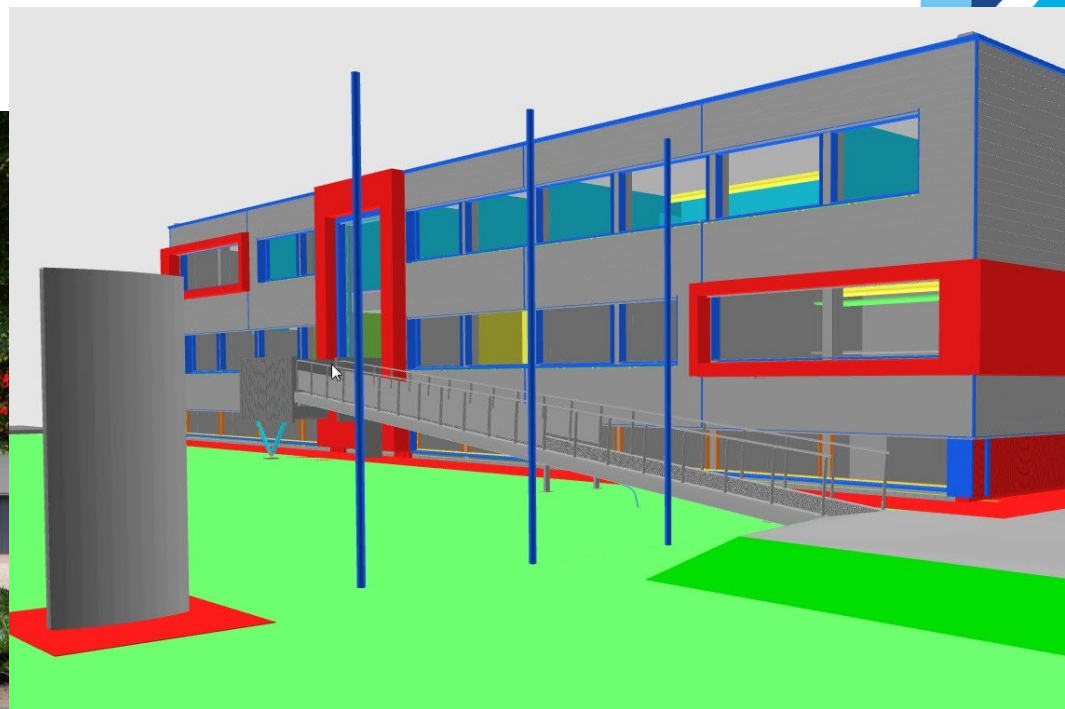

Bouwproject



idee



uitwerking

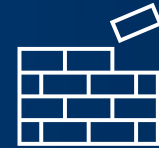

realisatie

Samenwerken



Opdrachtgever



Constructeur



Architect



Project



Onderaannemer



Installateur



Bouwbedrijf

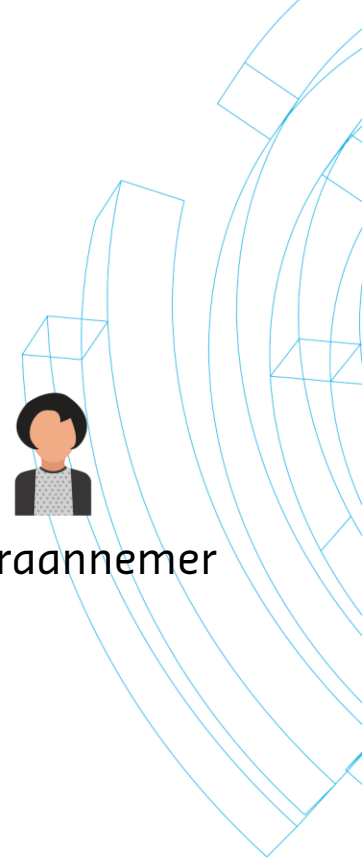

Communiceren

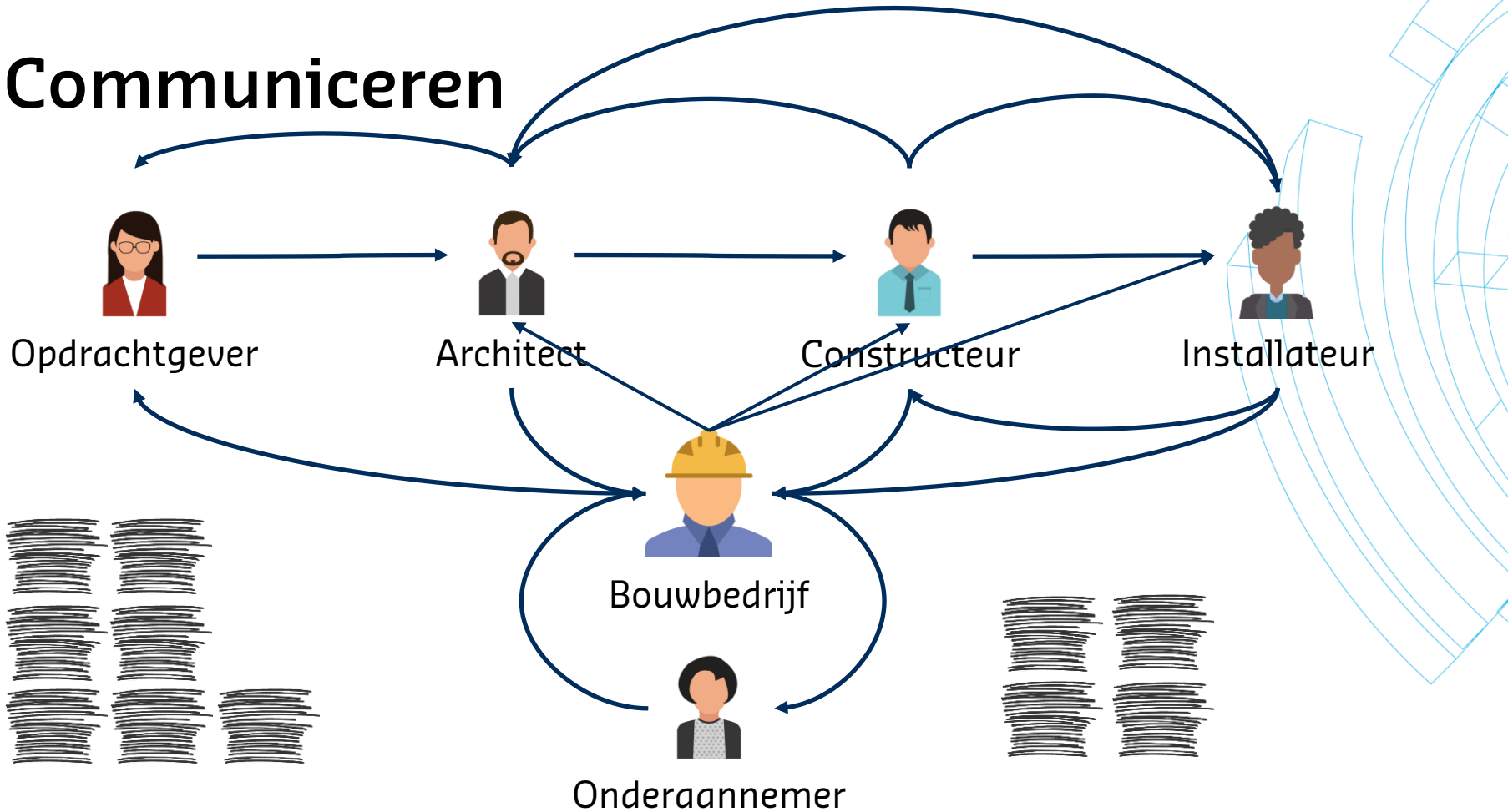

Communiceren

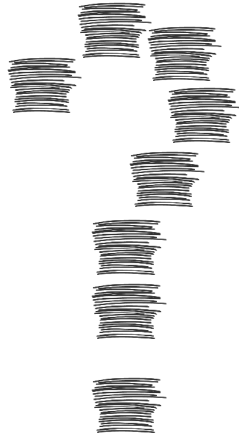

Waar en wat is de juiste informatie?

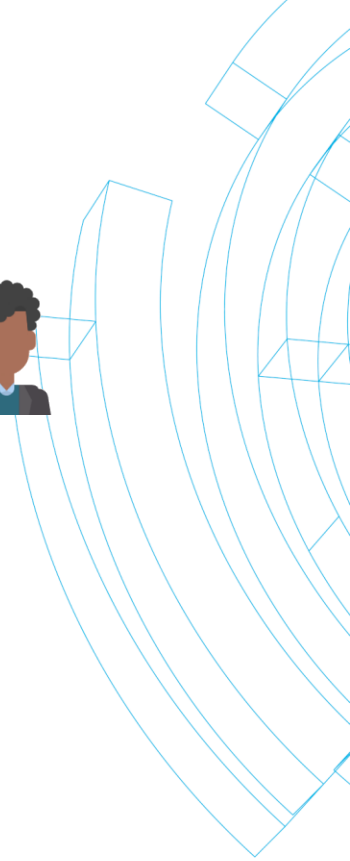

BIM Model



Architect

- Wensen opdrachtgever
- (Schets)ontwerp
- Functioneel en regelgeving



Constructeur

- Bepalen en berekenen draagconstructie



Installateur

- Bepalen en berekenen installaties
 - Verwarmen/Koelen
 - Ventilatie

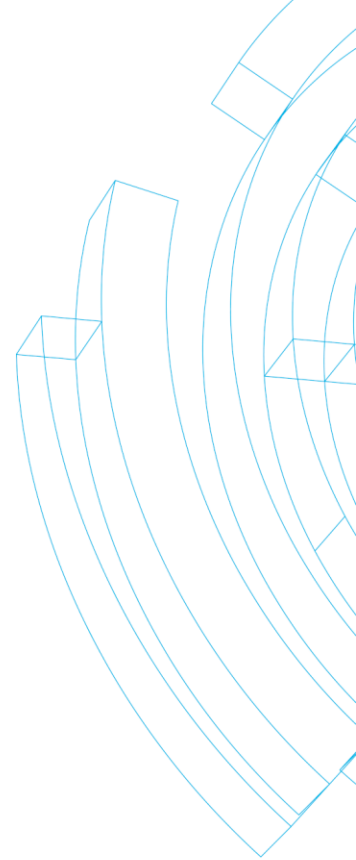

BIM Model

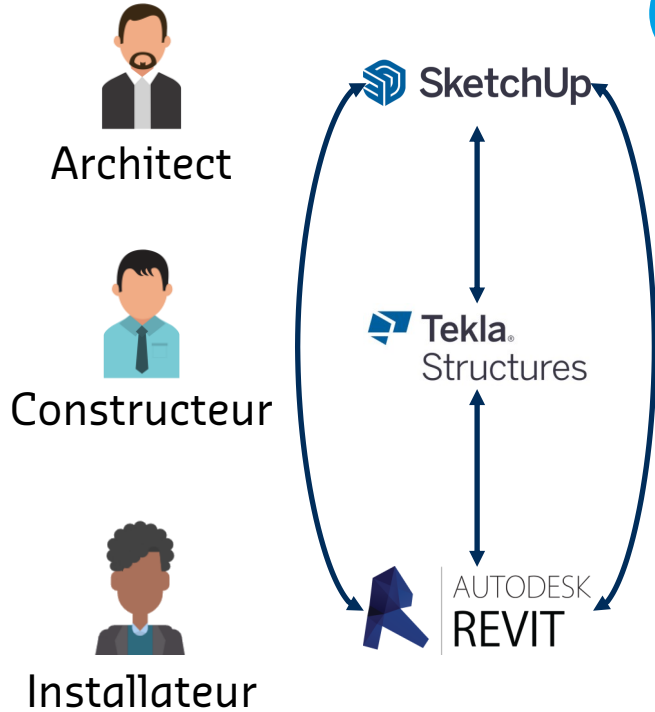

Bouwbedrijf

- Spin in het web
- Coördinatie verschillende disciplines
- Uitvoering project



Samenwerken



Opdrachtgever



Constructeur



Onderaannemer



Architect



Installateur



Bouwbedrijf

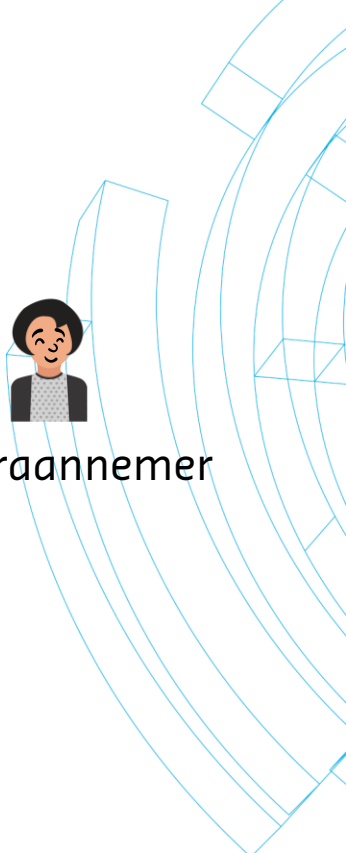



Wat is Trimble Connect?

Trimble Connect in het onderwijs

Trimble Connect in het onderwijs

- BWI platform in Trimble Connect
- Data voor iedereen toegankelijk:
 - Opdrachten
 - 3D Modellen
 - Tekeningen

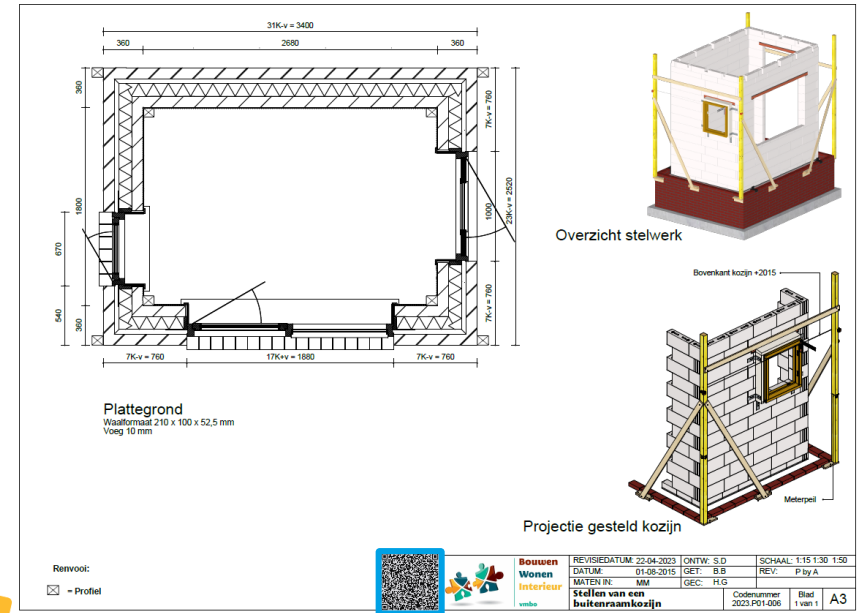

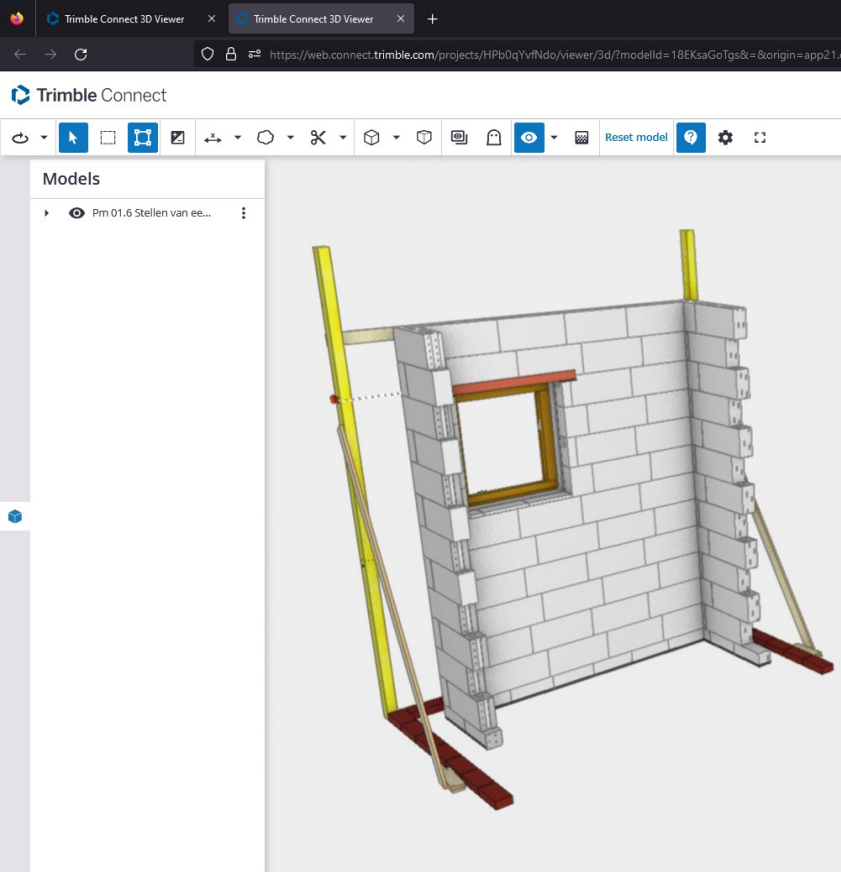

LIVE



Ervaar het zelf

- Wat is de hoogte van onderkant kozijn?
- Verf het kozijn in de gewenste kleur.

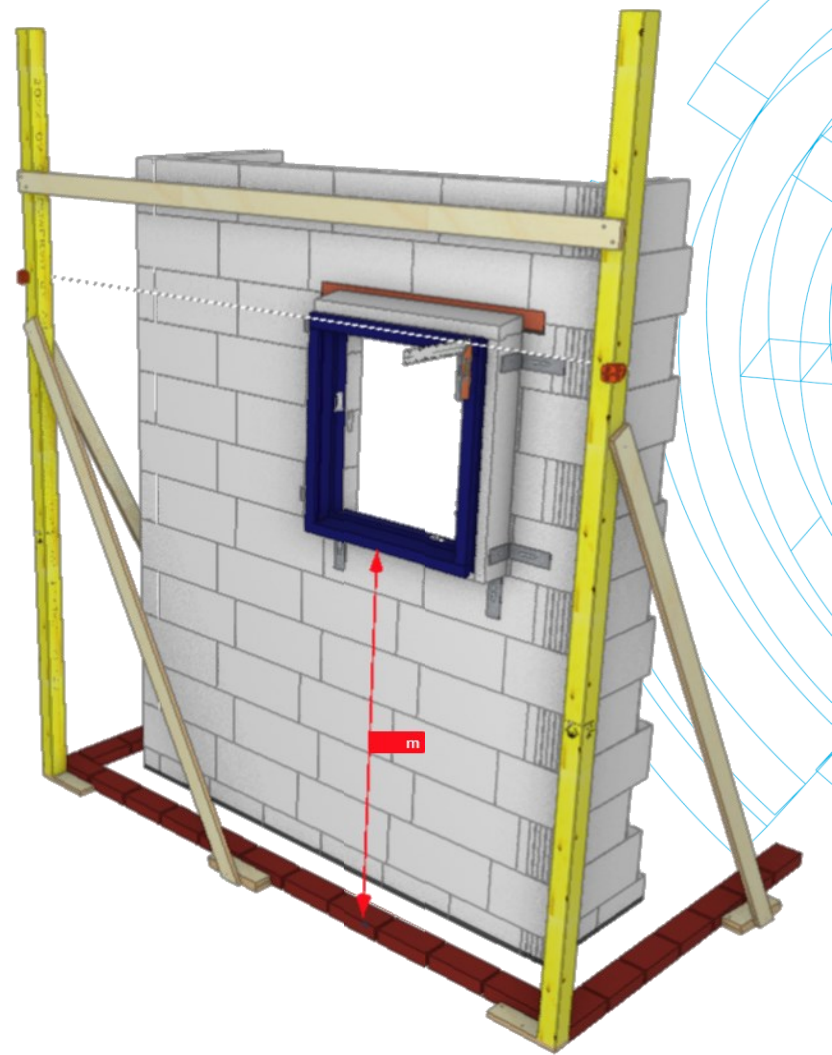

LIVE

Bē

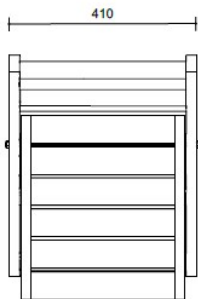

BOVENAANZICHT



ISOMETRISCHE PROJECTIE

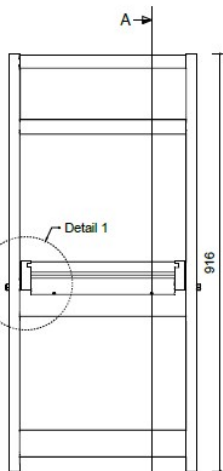

VOORAANZICHT

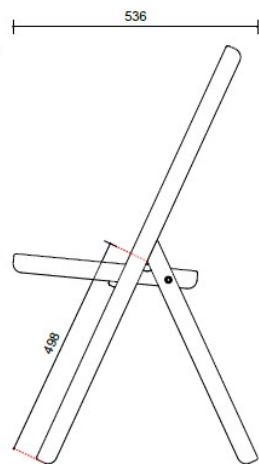

ZUAANZICHT

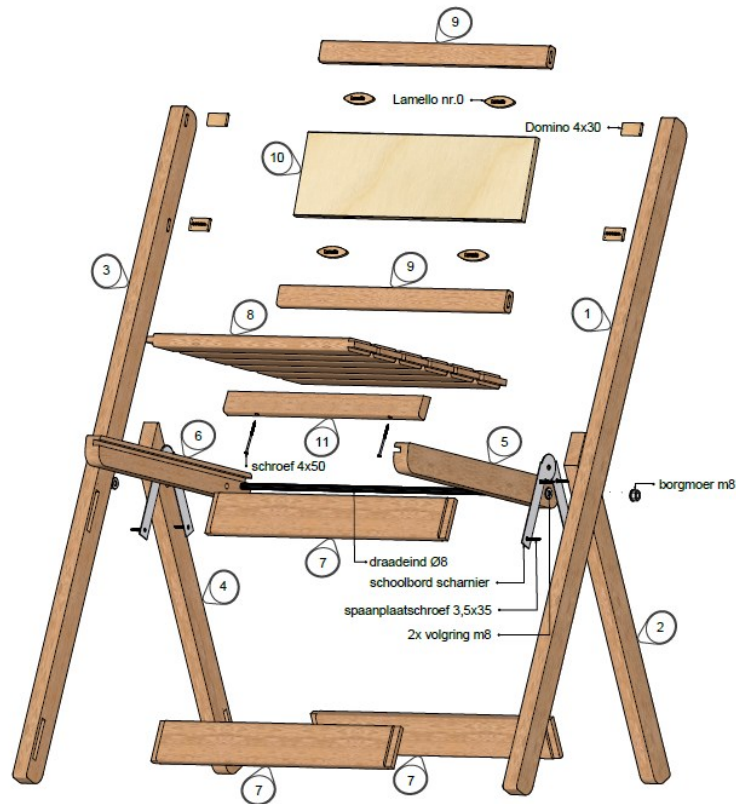

BW-K16.4 Tek. 1



**Bouwen
Wonen
Interieur**
vmbo

REVISIEDATUM: 21-04-2023	ONTW: P by A	SCHAAL: 1:5 / 1:8 / 1:10
DATUM: 16-02-2023	GET: P by A	REV: P by A
MATEN IN: MM	GE: H.G.	
Codenummer 2022.K16-004		Blad 1 van 2
Klapstoel		A3

B€

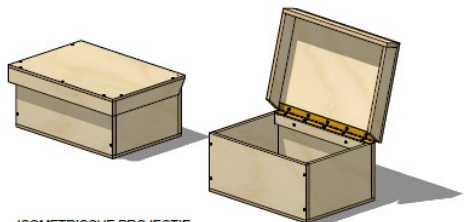

ISOMETRISCHE PROJECTIE

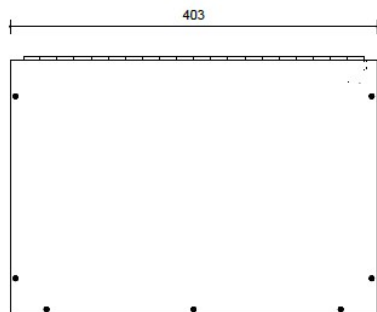

BOVENAANZICHT

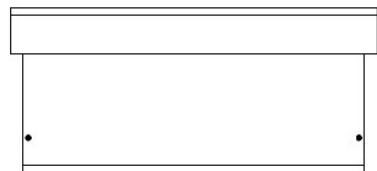

VOORAANZICHT

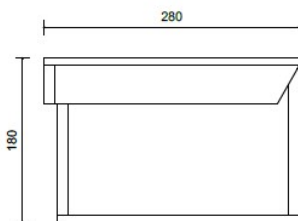

ZIJEAANZICHT

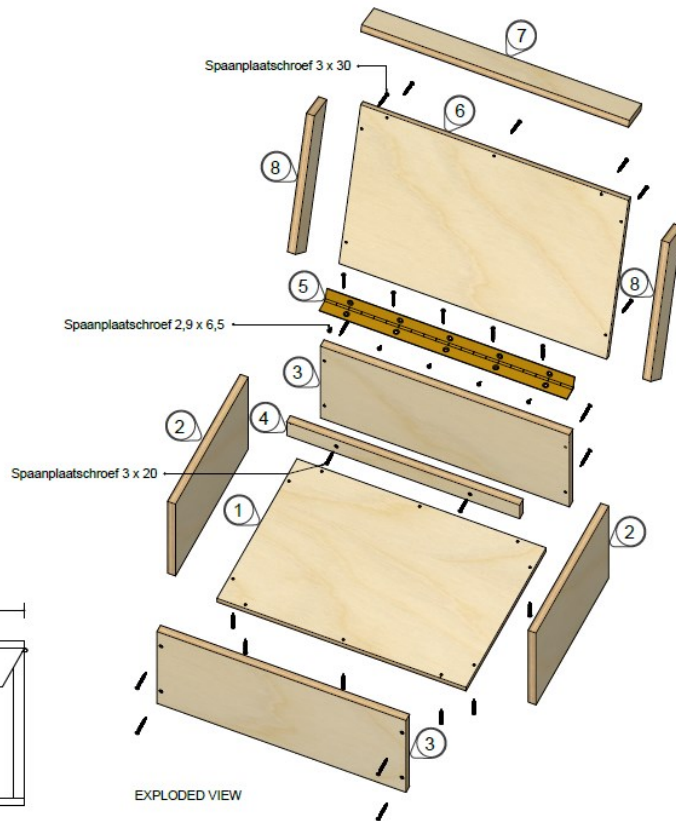

EXPLODED VIEW

BW - Kv. 19.3 Tab. 1



**Bouwen
Wonen
interieur**
vmbø

REVISIEDATUM: 06-05-2023	ONTW: J.K.L.	SCHAAL: 1:4 / 1:5 / 1:8
DATUM: 11-01-2022	GET: P by A	REV: P by A
MATEN IN: MM	GEC: H.G.	

Opbergbox

Codenummer
2022.K19-003

Blad
1 van 2

A3

Bē

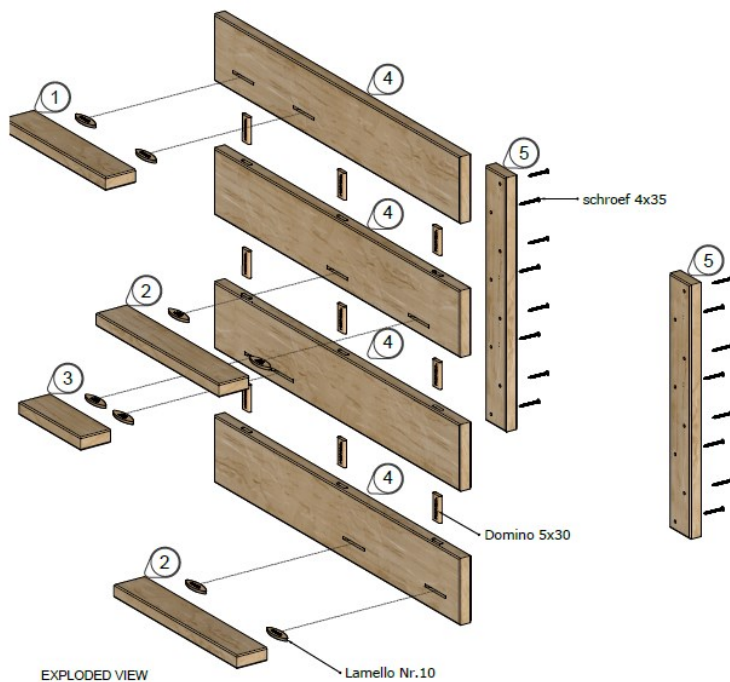
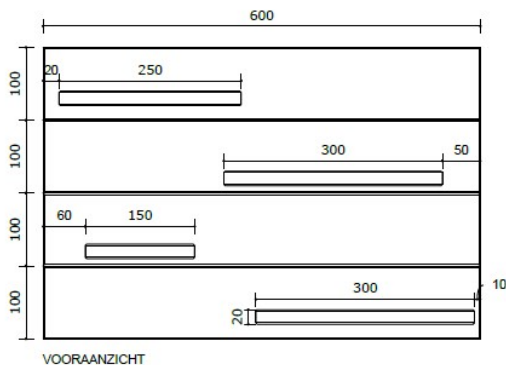
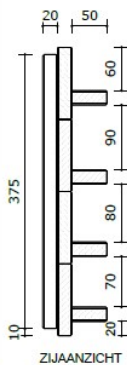
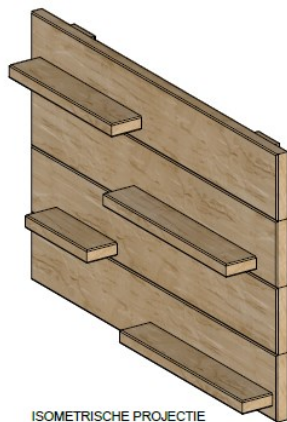

1

Bilrage Praktijkopdracht



	REVISIEDATUM: 17-05-2023	ONTW: JK & BM	SCHAAL: 1:5
	DATUM: 11-10-2021	GET: P by A	REV: P by A
	MATEN IN: MM	GEC: T.K.	
	Wandbord van resthout		Codenummer 2021.K22-001 Blad 1 van 1

A3

B€



ISOMETRISCHE PROJECTIE

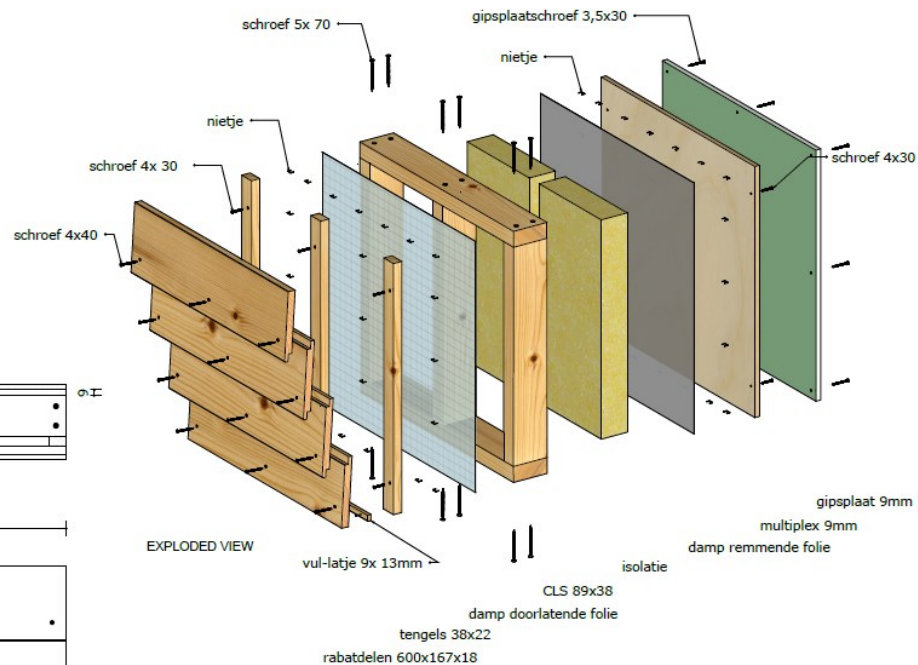

EXPLODED VIEW

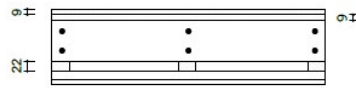

BOVENAANZICHT

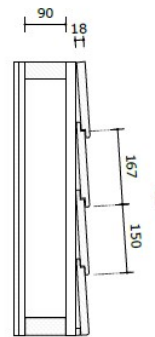

ZIJAAANZICHT

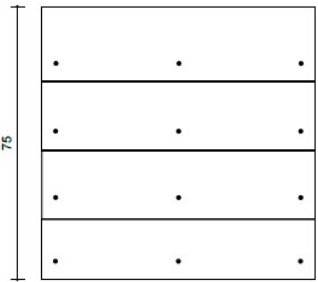

VOORAANZICHT

BW-KV-22.5 Tab. 1



Bouwen Wonen Interieur
vmbø

REVISIEDATUM: 16-05-2023	ONTW: JK & BM	SCHAAL: 1:8
DATUM: 12-10-2021	GET: P by A	REV: P by A
MATEN IN: MM	GEC: T.K.	
Circulaire gevel		Codenummer 2021.K22-05
		Blad 1 van 1
		A3

Be

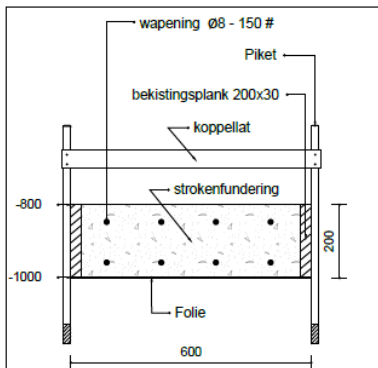

Maten en houtwaarte kunnen worden aangepast aan de school situatie

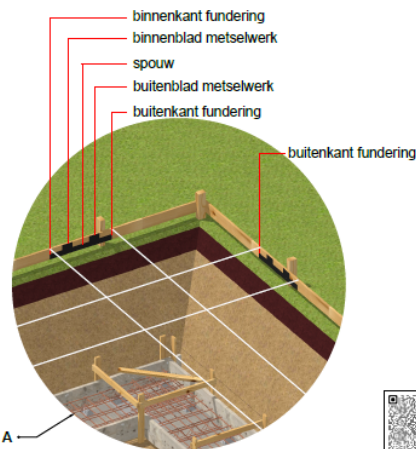
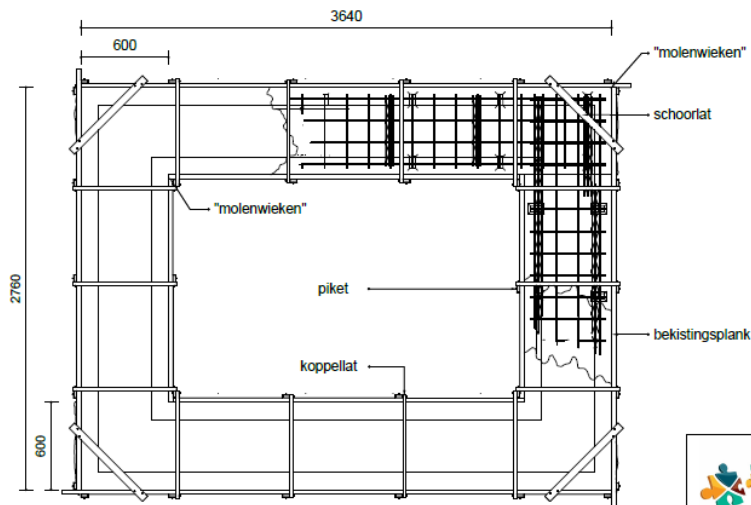
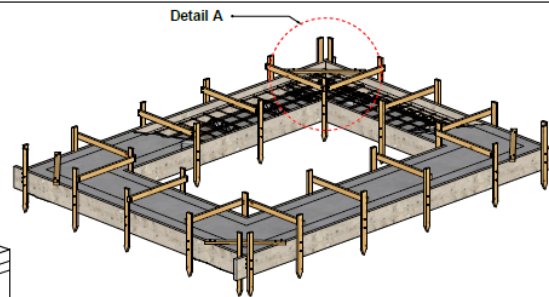
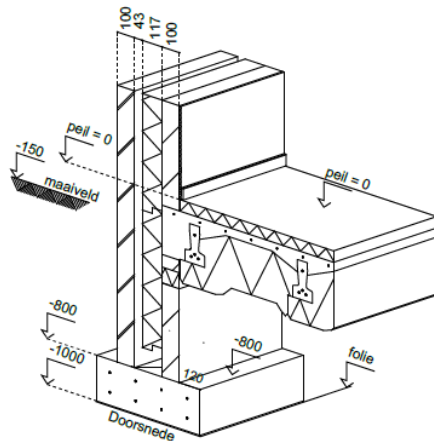

BW - P002.1 Tak 1



**Bouwen
Wonen
Interieur**
vmbø

REVISIEDATUM: 27-04-2023
DATUM: 01-08-2015
MATEN IN: MM

ONTW: D.K
GET: B.B
GEC: H.G

SCHAAL: 1:10, 1:15, 1:25
REV: P by A

Een stevig fundament

Codenummer
2023.P02-001

Blad
1 van 1

A3

Het aanmaken van lesmateriaal

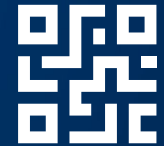
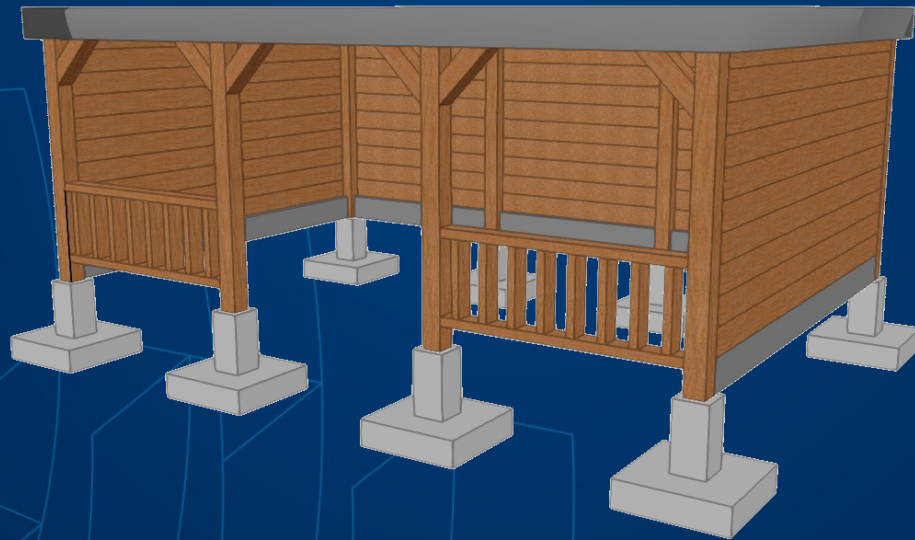

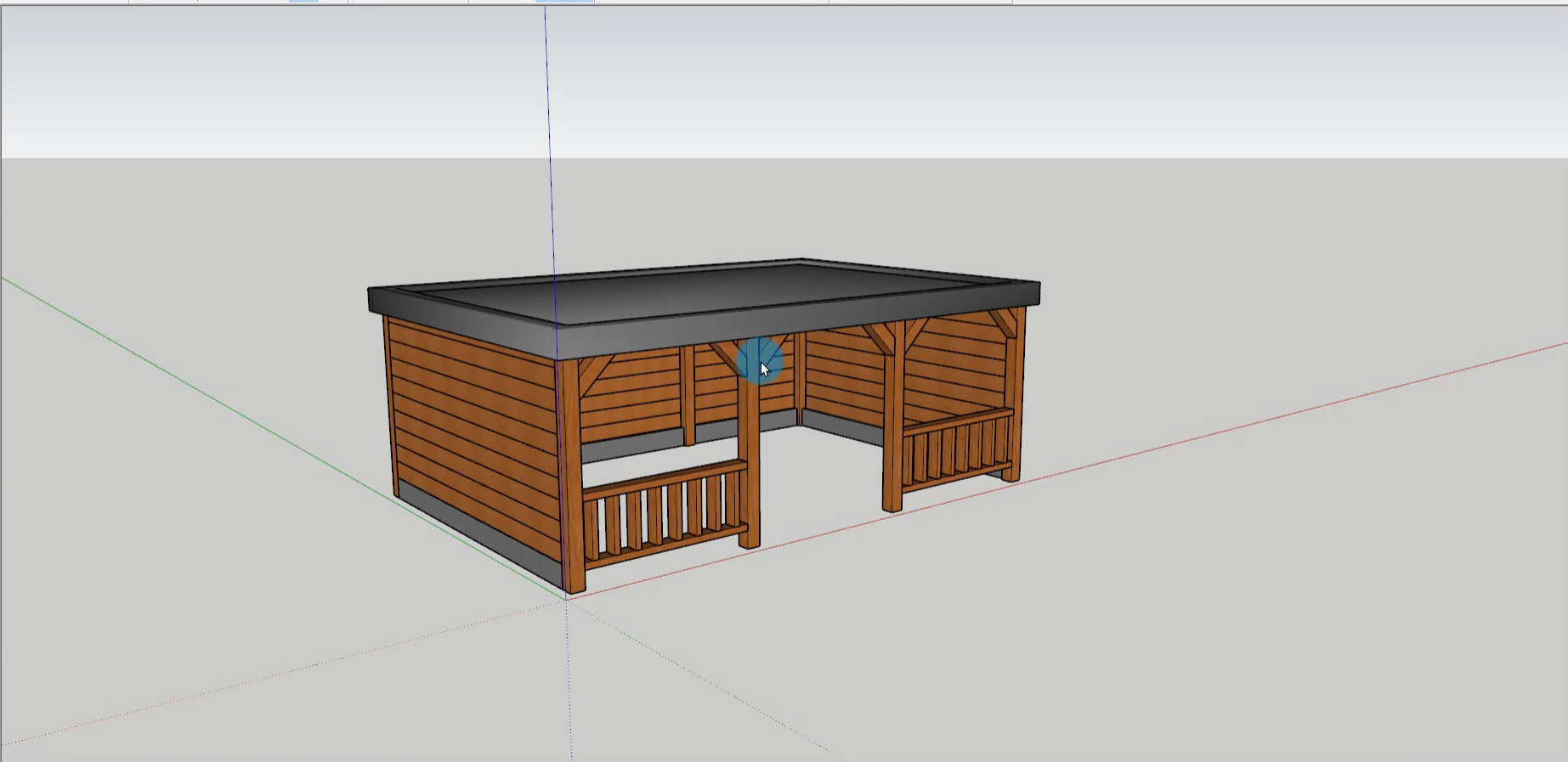

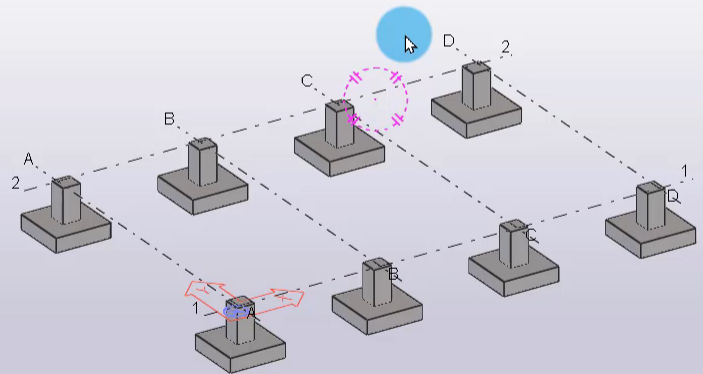
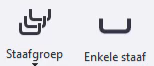
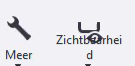
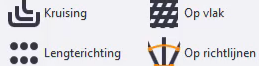
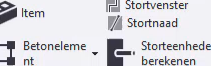
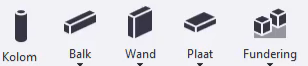
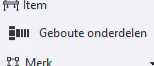

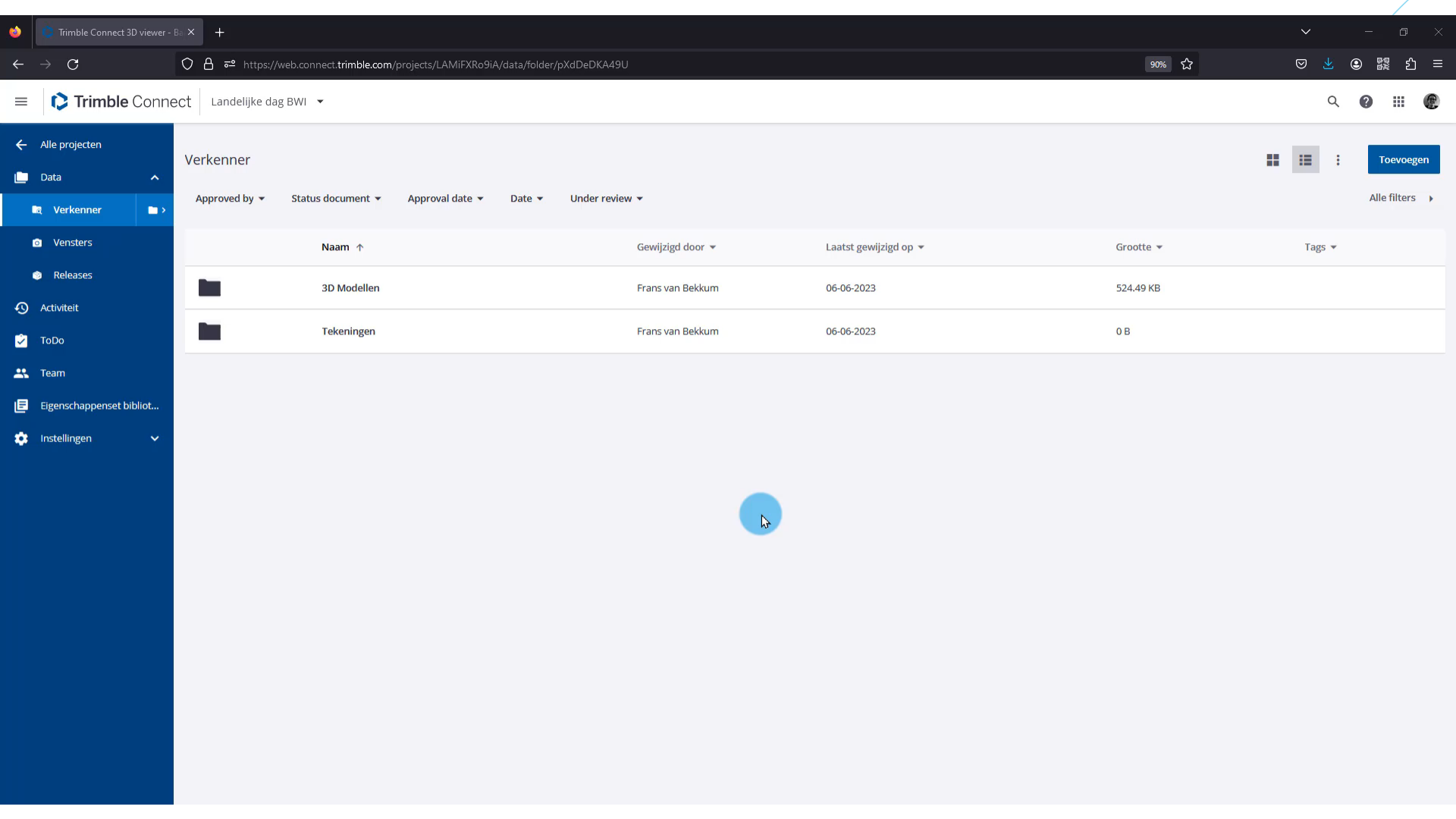

← Alle projecten

Data

Verkenner

Vensters

Releases

Activiteit

ToDo

Team

Eigenschappenset bibliot...

Instellingen

Verkenner

Approved by ▾ Status document ▾ Approval date ▾ Date ▾ Under review ▾

Alle filters ▾

	Naam ↑	Gewijzigd door ▾	Laatst gewijzigd op ▾	Grootte ▾	Tags ▾
	3D Modellen	Frans van Bekkum	06-06-2023	524.49 KB	
	Tekeningen	Frans van Bekkum	06-06-2023	0 B	



3D Model naar Trimble Connect

- Rechtstreekse koppelingen beschikbaar



- Resultaat:

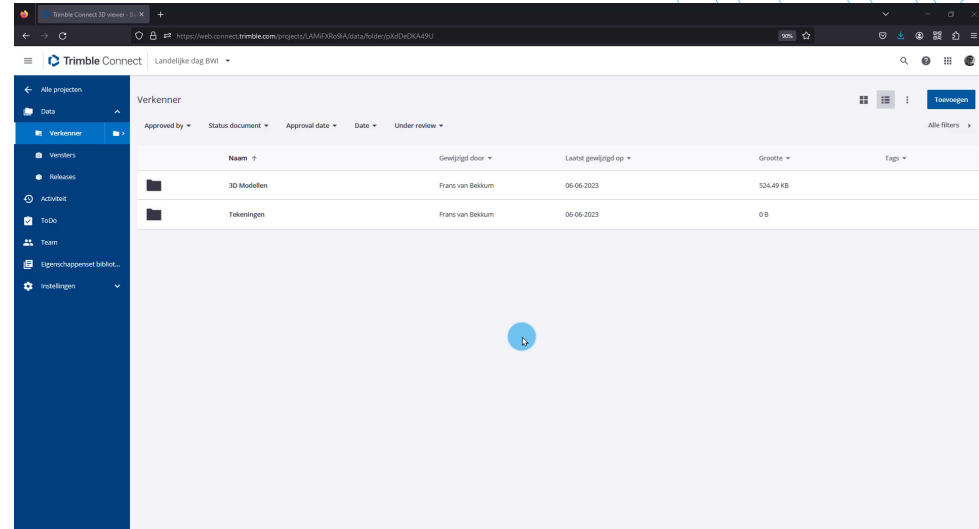



- ← Alle projecten
- Data
- Verkenner**
- Vensters
- Releases
- Activiteit
- ToDo
- Team
- Eigenschapsset bibliot...
- Instellingen

Verkenner

Alle filters

Toevoegen

Approved by	Status document	Approval date	Date	Under review
Naam ↑	Gewijzigd door	Laatst gewijzigd op	Grootte	Tags
 3D Modellen	Frans van Bekkum	06-06-2023	524.49 KB	
 Tekeningen	Frans van Bekkum	06-06-2023	0 B	



[Trimble Connect] Frans van Bekkum has s

Bestand Bericht Help ESET

Verwijderen Archiveren Beantwoorden Allen beantwoorden Doorsturen

Verwijderen Reageren

[Trimble Connect] Frans van Bekkum has shared p

 Frans van Bekkum (Trimble Connect) <noreply@trimble.com>
Aan  Frans van Bekkum

 Deze afzender noreply@trimble.com is afkomstig van buiten uw organisatie.

 Als er problemen zijn met de weergave van dit bericht, klikt u hier om het in ee



In-/uitzoomen Beantwoorden met planningspeiling Bericht vertalen Bericht rapporteren Viva Insights

/uitzoomen Tijd zoeken Translator Beveiliging Invoegtoe...

antwoorden  Allen beantwoorden  Doorsturen  

di 6-6-2023 11:35

Informatie delen

- Deelbaar maken voor iedereen!



- QR markering printen/verwerken
- Te benaderen voor iedereen 😊

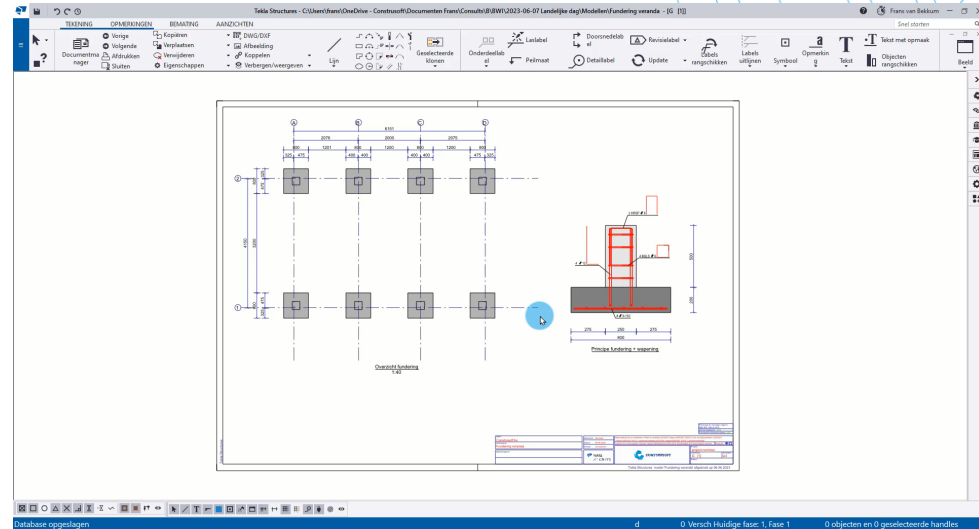

Informatie delen

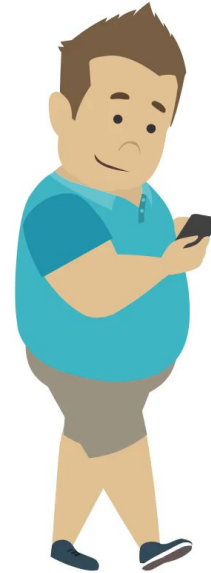
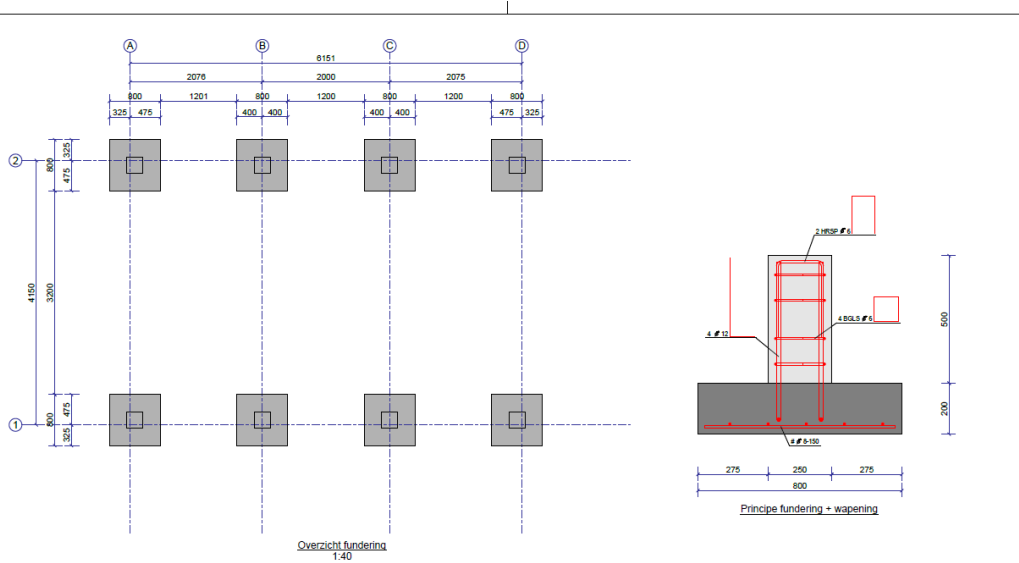

QR code	Opgesteld door: CONSTRUSOFT B.V.	Bestand: verand	Bestemmingsplan: Bestemmingsplan 'Pruim en groen' 2014-2019 (B-14)	Projectnummer: 11
	Fundering verand	Datum: 06.05.2023	Project: 11	Blad: A3
		Telka Structures	CONSTRUSOFT	

Telka Structures model 'Fundering verand' afgedrukt op 06.05.2023

The background features abstract, light blue geometric shapes, including lines and polygons, scattered across the dark blue field. The shapes are most prominent in the top-left and bottom-left corners, creating a modern, architectural feel.

Mogelijkheden met Trimble Connect Educational

Trimble Connect Educational

- Weergaven opslaan middels *Vensters*
- Communicatie middels *ToDo's*
- Gebruiken informatie

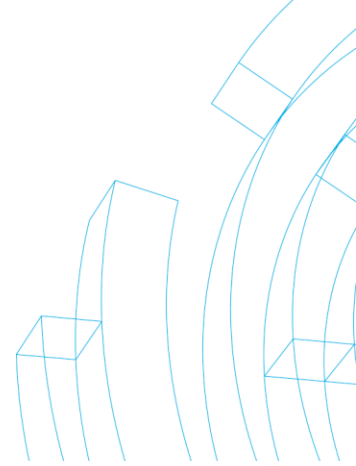

The screenshot shows the Trimble Connect software interface. At the top, there is a navigation bar with the Trimble Connect logo and the text "Landelijke dag BWI". Below this is a toolbar with various icons for navigation and editing. The main area displays a 3D model of a building component, which is a rectangular base with a vertical rectangular column on top. Below the 3D view is a table with the following data:

GROEPER OP:	Material	Name	Aantal	NetVolume	NetWeight
>	B500 (B)		8	--	--
>	B500A (4B)		48	--	--
√	CONCRETE/C20/25 (16)		16	1.27 m³	3.058t
>	POER (B)		8	1.02 m³	2.458t
>	STIEP (B)		8	0.25 m³	0.6t
Totaal 72			-	1.27 m³	3.058 t

LIVE

Breng de modellen tot leven!



AR

 Trimble Connect

MR



Instrueren met Trimble Connect MR



Navigeren

Uitlijnen

Model

Extra

Meten

Samenwerken

Afsluiten

Breng de modellen tot leven!



AR

 Trimble Connect

MR

Breng de modellen tot leven!











AR

 Trimble Connect

MR



Trimble Connect

 <p>BIM Onderwijsdag 2022</p>	 <p>Construsoft_demoproject</p>	 <p>Rule based Organizer</p>
 <p>Samenwerking TS & TC</p>	 <p>M2207 0373</p>	 <p>Test Buddies</p>
 <p>BARLI - BIM Awards</p>	 <p>BuroT</p>	 <p>BCF Topics - Tekla</p>

Navigation icons: Search, Filter, Sort, Refresh

Ervaringen uit de praktijk



Theorie naar praktijk

 Trimble Connect



Zelf aan de slag?

- web.connect.trimble.com
- Construsoft Campus

The screenshot shows the 'CONSTRUSOFT CAMPUS' web application. The top navigation bar includes 'Mijn cursussen' and 'Contact'. The main content area features a banner for 'De basis van Trimble Connect' with a 'Zet wijzigen aan' button. Below the banner, the breadcrumb trail reads 'Startpagina / Mijn cursussen / Trimble Connect basis / 1 | De viewers gebruiken / 1 | De viewers gebruiken'. The current page is titled '1 | DE VIEWERS GEBRUIKEN' and '01. 02 | DE 3D-VIEWER GEBRUIKEN'. The main content area contains a video player with a play button and a dark blue overlay with the 'CONSTRUSOFT' logo and 'E-LEARNING Trimble Connect' text. Below the overlay, it says 'Basis functionaliteiten van de 3D viewers'. On the right side, there is an 'Inhoudsopgave' (Table of Contents) section with two items: '01. 01 | De 2D-viewer gebruiken' and '01. 02 | De 3D-viewer gebruiken'. The left sidebar contains a navigation menu with items like 'Trimble Connect basis', 'Deelnemers', 'Cijfers', 'Welkom', and a list of course modules, with '1 | De viewers gebruiken' selected.

Bedankt!

Ontdek de mogelijkheden

GASTLESSEN



E-LEARNING

SOFTWARE



MIXED REALITY

 **Tekla.**
Structures
A Trimble Solution

 **SketchUp**
Pro
A Trimble Solution

 **Trimble**
Connect
A Trimble Solution

CONSTRUSOFT